

# Fully Automatic Coffee Machine

## User Manual



# A3

## Content

1	
Safety.....	03
Intended use.....	03
Warning.....	03
Explanation of safety symbols.....	04
2 Introduction.....	05
3 Machine overview.....	05
Operation panel: .....	06
4 Accessories.....	07
5 Preparing and using for the first time .....	07
Unpacking.....	07
Installing filter (optional) .....	08
Heating.....	08
Auto rinsing .....	08
Install milk carafe .....	08
6 Beverage preparation.....	09
How to prepare beverage.....	09
How to adjust grinding degree.....	10
How to prepare a drink with ground coffee.....	10
7 Machine Setting .....	11
Cleaning and maintenance.....	11
Brewer cleaning.....	11
Descaling .....	11
Install/Change filter.....	12
Auto switch off .....	13
Eco mode.....	13
Factory reset.....	13
Empty water circuit .....	13
Select water hardness .....	13
8 Daily cleaning .....	14
Milk carafe assembly.....	14
9 Troubleshooting .....	15
10 Technical data.....	16
Disposal .....	16

# 1 Safety

## Intended use

A3 machines are designed to prepare standard household coffee and use in family or non-commercial sites similar to family environment. Other commercial sites such as staff canteen, hotel and other sites with more daily coffee consumption are not recommended to use the machine.

## WARNING

- \* Give the manual to the next user if the machine is sold or transferred.
- \* Only fill the water tank with fresh cold water.
- \* Treated with additives or caramelized coffee beans cannot be used.
- \* A3 is intended for preparing coffee and milk-based beverage. It is incorrect and dangerous for other purpose.
- \* Do not immerse the machine or power cord into water for cleaning. If error occurs, pull out the mains plug or cut off power supply immediately.
- \* Connection to the power supply can only be performed by the specification of rating plate, see technical data for more information (Page 16).
- \* A3 is not recommended to use outdoors, and needs to put it on the horizontal waterproof surface that can support its weight before use.
- \* Please ensure to put machine far away from the splashing water.
- \* If A3 is damaged (e.g., something burnt) or there is something wrong, pull out the mains plug and contact customer service. Maintenance must be performed by professional service technician.
- \* The manufacturer shall not be liable for damage resulting from improper use.
- \* Switch off the machine and pull out the mains plug, if the machine is not used for extended period (e.g., on vacation).
- \* A3 must be used between 5°C-40°C.
- \* Emptying water circuit needs to be performed in advance, if A3 will be stored at 0°C or below.
- \* Do not use damaged filter.
- \* Seal and store the filter in a dry place.
- \* Keep filter out of the reach of children.
- \* Filter should be placed far away from heat source and avoid direct sunlight.
- \* This appliance is not intended for use by persons (including children) with reduced physical, sensory or mental capabilities, or lack of experience and knowledge, unless they have been given supervision or instruction concerning use of the appliance by a

person responsible for their safety.

- \* Children should be supervised to ensure that they do not play with the appliance.
- \* Cleaning and user maintenance shall not be made by children unless they are older than 8 and supervised.
- \* If the supply cord is damaged, it must be replaced by a special cord or assembly available from the manufacturer or its service agent.
- \* Keep the appliance and its cord out of reach of children aged less than 8 years.
- \* The coffee machine shall not be placed in a cabinet when in use.
- \* Always disconnect the appliance from the supply if it is left unattended and before assembling, disassembling or cleaning.
- \* Do not touch the coffee outlet and other heating surface with residual heat after making coffee.
- \* Please follow this manual to use the machine, misuse of the machine may cause injury.
- \* Empty remaining coffee beans or use them up before transportation, otherwise it will lead to errors.

## Explanation of safety symbols

Observation of these safety instructions is imperative to ensure personal safety and machine in good condition. Symbols and signal words indicate the level of hazards as follows:



**WARNING**

**WARNING** Indicates a potential danger, if not avoided, will probably result in death or serious injury.



**CAUTION**

**CAUTION** Indicates a hazardous situation which, if not avoided, could result in minor or moderate injury.



**NOTICE**

**NOTICE** Directs your attention to the risk of damage to machinery.

## 2 Introduction

Congratulations on the purchase of your fully automatic coffee machine! Read the user manual carefully prior to use A3 for the first time, and keep it well for reference later. The machine is only suitable for domestic occasions, not for commercial use.

## 3 Machine overview

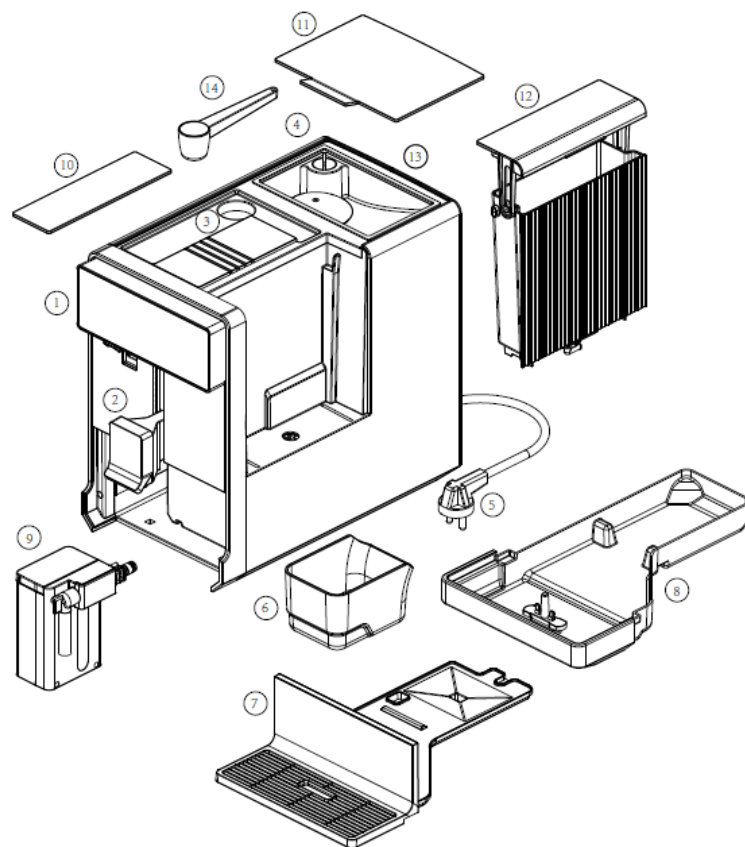

1. Operation panel
2. Adjustable coffee spout
3. Powder chute for ground coffee
4. Grinding wheel
5. Power cord
6. Grounds container
7. Drip tray cover

8. Drip tray
9. Milk carafe
10. Powder chute cover
11. Bean hopper cover
12. Water tank
13. Bean hopper
14. Spoon

## Operation panel:



Icon	Description	Icon	Description
	Coffee Strength adjustment		Filling water warning
	Ground coffee function		Empty grounds container warning
	Volume adjustment		Fill beans warning
	Milk foam adjustment		Install milk carafe indication
	Temperature preset		
	Milk carafe cleaning		
	Filter change indication		
	Brewer cleaning		
	Descaling		

## 4. Accessories

1. User manual
2. Powder spoon
3. Filter (**optional**)
4. Water hardness test strip (**optional**)
5. Cleaning agent (**optional**)  
(**Brewer cleaning tablet/Descaling cleaning agent/Milk system cleaning agent**)

## 5 Preparing and using for the first time

### Unpacking

1. Take out the machine and remove the protective film, then place it on a horizontal surface which is dry and non-slip.



- *After unpacking, whether the surface of machine is intact and without obvious scratch are both need to be ensured, as well as to ensure spare parts and accessories are complete. If the appearance is damaged seriously and/or some parts/accessories are missing, please, contact customer service.*
- *Coffee machines were tested at the manufacturer facilities before leaving the factory, so a little amount of ground coffee might be present in the coffee machine. This is normal.*

2. Remove water tank and rinse, then fill the water tank up to max;
3. Place the water tank back and ensure that it installed properly;
4. Fill the bean hopper with coffee beans;
5. Plug the mains cable for the coffee machine into an electrical outlet;



- *Heat will be released during beverage preparation, so the surrounding area around the coffee machine needs to be freed up to 3cm space at least, and top of it needs to be freed up to 15cm space at least.*
- *All round of the machine should avoid sharp or high temperature substances in case of damage to power cord.*

6. Turn on the power switch, then touch the screen button to start up the machine.
7. Water hardness setting is necessary when using the machine for the first time. Default setting is 4 level, see the end of page 13 for further details.

## Installing filter (optional)

Ensure the water filter is installed, touch 'OK' to continue.

Recommended filter: **BRITA** AquaAroma Crema Water Filter.

## Heating

The beverage light flashing in a clockwise cycle means machine is heating.

## Auto rinsing

Rinsing program of the device will be performed automatically. After finishing rinsing, you can use coffee machine.



- In the process of rinsing, hot water will come out from coffee spout to rinse. You can put a appropriate cup beneath the outlet to prevent scalding from splashing hot water.

## Install milk carafe

Please ensure that all parts of milk carafe are assembled correctly before inserting it into the machine.

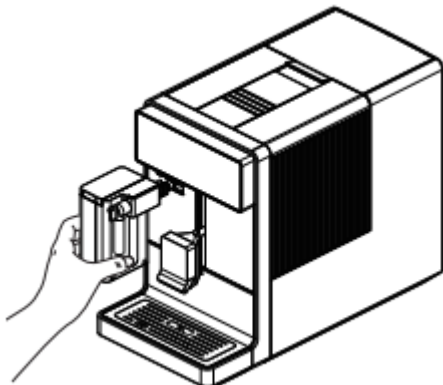



## 6 Beverage preparation

- Before preparing beverage, please ensure that there are sufficient water in the water tank, enough coffee beans in the bean hopper and no error messages appear on the display.
- Place an appropriate cup beneath the coffee spout, and adjust the coffee spout up and down to the suitable height.
- If milk-based beverage needs to be prepared, ensure components of milk carafe are installed correctly and filled with enough milk.



- *During beverage preparation, too higher dual spout may result in scalding because of splashing drinks.*
- *Hot steam will be sprayed from milk carafe spout when the milk is not enough.*



- *During milk preparation, noise made by milk carafe is normal.*
- *After milk beverage preparation, remember to rinse milk carafe in time to prevent milk residue or spoiled milk, and put the milk carafe into cooler timely.*

### How to prepare beverage

Touch desired beverage on the operation panel. Before making the drink, you can adjust the coffee strength, coffee cup volume, milk foam volume and temperature.



- *Do not reach into bean hopper during the beverage preparation*

### How to adjust grinding degree

Users can adjust grinding degree themselves by using grinding wheel from the bean hopper inside. Total nine levels can be adjusted according to your taste.

Turn clockwise for a coarser grind, and turn counterclockwise for a finer grind.



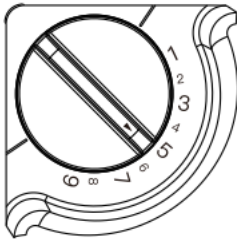

- *Grinding degree adjustment is only available when grinding the coffee beans*
- *New settings are available at the second or third cup of coffee*
- *Dark roast is suitable for fine grinding, light roast is suitable for coarse grinding.*

## How to prepare a drink with ground coffee

1. Take out the powder chute cover and put ground coffee into machine;
2. Long press the coffee strength button for 3 seconds to trigger the coffee powder function;
3. Press any coffee beverage, and machine begins to prepare coffee.

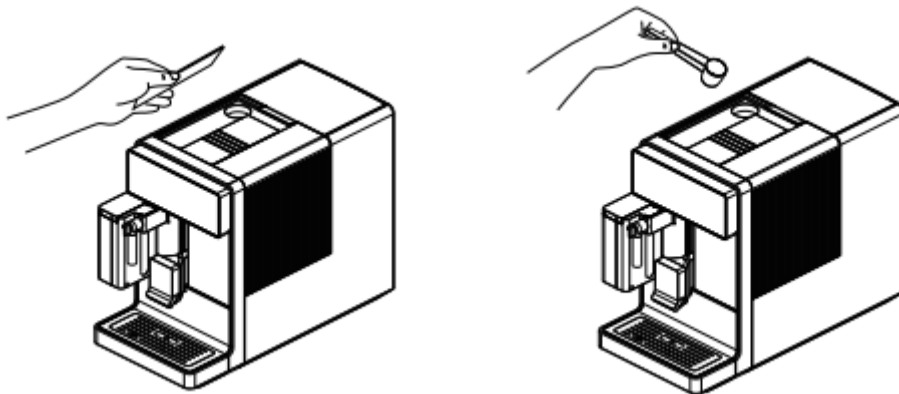











- *Here we suggest to use powder spoon in box (full powder capacity of spoon is 6g). Since the recommended range for coffee powder is 5~12g.*













# 7 Machine Setting

## Cleaning and maintenance

### Brewer cleaning

1. Press  for 3 seconds, until all 3 lights flash .
  2. Press  for 3 seconds, until all lights flash .
  3.  on, means user need pull out and empty drip tray.
  4. After replacing drip tray, press .
  5. Place a cup under the coffee spout before cleaning the machine.
  6.  light on, it means that you need drop clean tablet into coffee powder chute
  7. Press , light begins to flash, then continue to perform clean procedure.
  8.  on, it means that user need pull out and empty drip tray.
  9. After replacing drip tray, brewer cleaning is finished.
- Attention: If  on during cleaning process, you need to add enough water, then clean automatically.

### Descaling

1. Press  for 3 seconds, until all 3 lights flash .
  2. Press  for 3 seconds, until all 3 lights flash .
  3.  on, it means that user need pull out and empty drip tray
  4. After replacing drip tray.  on, it means that user need to take out water tank, fill water and mix descaling agent in water tank, then replace water tank.
  5. After replacing drip tray. Press .
  6. Place a cup under the coffee spout before cleaning the machine.
  7.  on, it means that user need pull out and empty drip tray
  8. After replacing drip tray,  on, it means that users need to take out water tank, fill water, then replace water tank
  9. Press  to clean, until  on, it means that user need pull out and empty drip tray
  10. After replacing drip tray, descaling is finished.
- Attention: If  on during cleaning process, you need to add enough water, then clean automatically.



- *Read the user manual and usage of cleaning agents carefully prior to cleaning process.*
- *During descaling, be careful and avoid to touch acid hot water dispensing from coffee spout.*
- *Long press temperature adjustment button for 3 seconds can also activate descaling/brewer cleaning function when machine is standby.*



- *Descaling for the machine at regular intervals to avoid water residuals accumulation, which will lead to the increase of energy consumption.*
- *Do not use vinegar, citric acid or scale remover.*

## Install/Change filter

Long press the filter change button for 3 seconds, then indicator flashes yellow, touch the filter change button, the fill water indicator is on, the water tank is taken away and the filter is installed, then the tank is put back, and the filter cleaning process is entered.

When the filter use expires, the indicator light turns red, prompting the user to replace the filter, the user long presses the filter change button for 3 seconds, the tank water shortage light is on, the tank is taken away and the filter is replaced, the tank is put back, and the filter cleaning process is entered.



- *The device will not detect whether install filter or not automatically, which need users to confirm themselves and activate the function to use.*
- *Even though without message displayed for replacing the filter, user also should to change the filter every 3 months.*

## Auto switch off

Long press temperature adjustment for 3 seconds, you can click coffee volume adjustment light to change light amount, which means different auto off time setting:

Light amount	Auto off time
1	15min
2	45min
3	90min

## Eco mode

Long press temperature adjustment for 3 seconds, press Americano button:  
Indicator on means ECO mode is on, indicator is off meaning ECO mode is off.

## Factory reset

Long press temperature adjustment for 3 seconds, press Coffee button for 3 seconds to perform factory reset.

## Empty water circuit

Long press temperature adjustment for 3 seconds, fill water indicator is on, then please take out the water tank, press espresso button to perform empty water circuit process.

## Select water hardness

Use the test strip(optional) to test water hardness, you will then be able to adjust the water hardness of machine according to the testing results.

You can set your water hardness setting by the chart below, based on your water source condition.

Long press temperature adjustment for 3 seconds, press coffee strength adjustment button to change water hardness level

Indicator position	level	Water hardness
1	1	1~7dH
2	2	8~15dH
3	3	16~23dH
4	4	24~30dH



- *We recommend you adjust the water hardness to your local water hardness condition, in order to keep the machine in optimum performance and extend the life span, meanwhile, getting rid of troubles resulting from descaling frequently.*
- *Default water hardness setting is the maximum level of water hardness.*

## 8 Daily cleaning

For better use of coffee machine and beverage preparation, following components if used need to be cleaned manually on the day:

- Grounds container
- Drip tray
- Drip tray grid
- Water tank
- Coffee spout
- Milk carafe assembly
- Operation panel



- *Before cleaning, ensure that mains plug has been pulled out and do not immerse the device into the water.*



- *Except for other parts, dishwasher cleaning for milk carafe is available.*
- *Do not use corrosive and chemical solvent cleaning agent or alcohol to clean the machine.*

### Milk carafe assembly

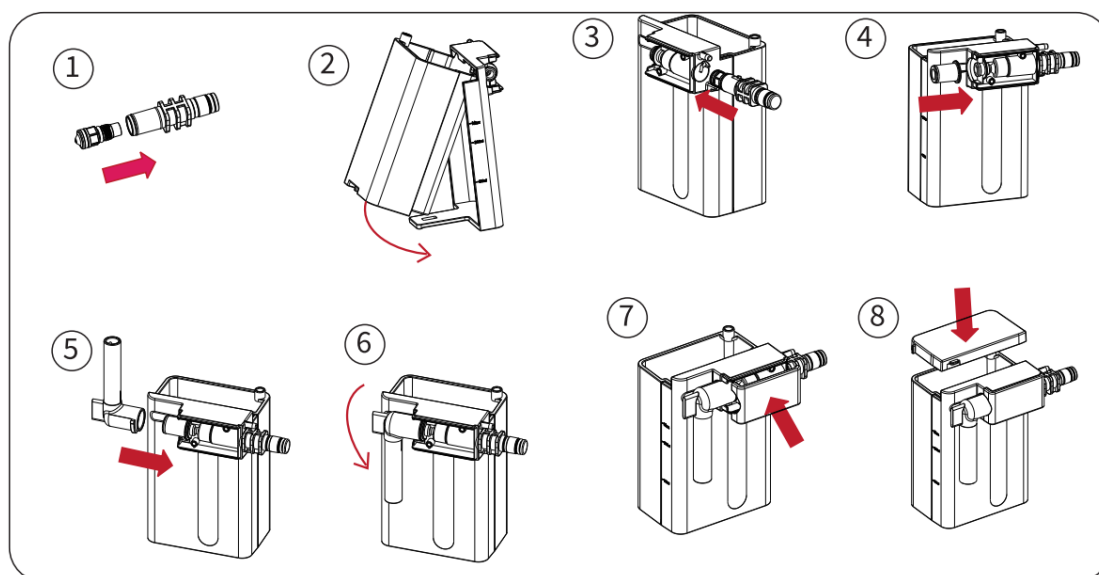

(Please contact customer service if you meet any problem when assembling Milk carafe)



- To avoid clogging, it is necessary to rinse after using.
- Do not put your hands beneath the steam outlet during operation.
- Disassembly rinsing is allowed.

## 9 Troubleshooting

This chapter has summarized all errors of coffee machine, common malfunctions and solutions. If the problem cannot be solved, please contact customer service in your country or region.

<b>Problem</b>	<b>Reason</b>	<b>Resolution</b>
Milk sprays out of the milk carafe when making milk foam	Milk is running out	Fill milk carafe with milk
	Milk system is clogged	Perform milk system cleaning
	Milk carafe not install correctly	Reinstall milk carafe
Too little or not enough steam	Water scale is too much inside of machine	Perform descaling
Grounds container cannot be removed together with drip tray; Or drip tray and grounds container cannot put back in machine.	Brewer inside has interference with grounds container	Firstly, remove grounds container manually, Then put drip tray alone back to machine. Restart the machine until ready to make coffee. Take out drip tray and put it and grounds container together into machine.
Coffee not dispensing or coffee flows slowly	Coffee powder is too fine	Increase the grinding level
	Clogging inside the coffee system	Perform coffee system cleaning
	Coffee spout clogging	Clean coffee spout
	Clogging inside the machine due to limescale	Perform descaling procedure
All warning indicator flash	Machine has malfunction inside.	Touch power button to switch off the machine directly. If error occurs again after restarting, please contact service center

## 10 Technical data

<b>Product name</b>	Fully automatic coffee machine
<b>Model</b>	A3
<b>Recommended daily capacity</b>	10 cups
<b>Bean hopper</b>	200g
<b>Water tank</b>	1.3L
<b>Milk carafe</b>	250ml
<b>Drip tray</b>	600ml
<b>Grounds container</b>	10 portions
<b>Height-adjustable for coffee spout</b>	68-138mm
<b>Water pump pressure</b>	19 bar
<b>Power supply</b>	220-240V 50/60Hz
<b>Power rating</b>	1400w
<b>Dimensions (W x H x D)</b>	215×340×455mm
<b>Net weight</b>	8.8kg-9.6kg

## Disposal



The device may not be disposed as domestic waste. It needs to be transfer to specialized garbage classification center.